

HEAT DISSIPATION ANALYSIS OF RUGGED SYSTEM USED IN DEFENCE APPLICATIONS

DVVS Bheemeshwar Reddy S¹,

Grandhi V Ayyappa Swamy² , K.L.Kishore³

¹Asst.Professor ,Dept., of Mechanical Engineering, Aditya Engineering College,

Surampalem, Kakinada.

²Asst.Professor, Dept., of Mechanical Engineering, Aditya College of Engineering,

Surampalem,Kakinada.

³sr Asst. Professor, Dept., of Mechanical Engineering, Aditya Engineering College,

Surampalem, Kakinada.

ABSTRACT

A rugged system is a system specifically designed to operate reliably in harsh usage environments and conditions, such as strong vibrations, extreme temperatures and wet or dusty conditions. They are designed from inception for the type of rough use typified by these conditions, not just in the external housing but in the internal components and cooling arrangements as well. Typical end-user environments for rugged laptops, tablet PCs and PADs are public safety, field sales, Field service, manufacturing, retail, healthcare, transportation/distribution and the military. They are used in the agricultural industries and by individuals for recreational activities.

The rugged system is used for carrying the sensitive items for one place to other place without damaging. The products like computers, guns, medicine, walk talky etc. to withstand harsh conditions. The rugged system provides the good conditions while traveling, it keep the devices clean, protected from water, dust, vibrations, and fire to and environmental conditions and more.

This paper mainly focused on the better position for placing fans to cool the electronic system.

In this paper we designed a rugged casing using CREO-2.0 and CFD analysis for rugged box and inner part electronic component takes place with help of FLOEFD Software.

Keywords— Rugged ,Casing , Design

I. INTRODUCTION

Rugged is strongly made and capable of withstanding rough handling. A rugged system is a system specifically designed to operate reliably in harsh usage environments and conditions, such as strong vibrations, extreme temperatures and wet or dusty conditions. They are designed from inception for the type of rough use typified by these conditions, not just in the external housing but in the internal components and cooling arrangements as well. Typical end-user environments for rugged laptops, tablet PCs and PADs are public safety, field sales, Field

service, manufacturing, retail, healthcare, transportation/distribution and the military. They are used in the agricultural industries and by individuals for recreational activities.

Defense solutions these days demand the highest level of technology. Combined with increased customer demands for short development cycles and lower cost, these demands pose a major challenge to system engineers. Building a system for defense applications involves high-reliability COST products, custom hardware design, mechanical and electrical integration followed by qualification test to ensure that they meet the required military standards. While building systems to meet rugged military standards care has to be taken on certain crucial aspects during the design stage itself. If this is not done, the system may not meet the rugged requirements specs and hence not qualify for the rugged military standards.

II. RUGGEDIZATION

Levels of Ruggedization

We are using ruggedizing in very harsh environments. This are divided into three accepted levels of ruggedization: semi-rugged, fully-rugged and ultra-rugged. The levels ability to survive drops vibration, dust, immersion and extreme temperatures.

Semi-rugged devices, which are increasingly being called business-rugged by marketers, are usually enhanced versions of commercial off-the-shelf (COTS) hardware. The components are the same, but they are protected better. For example, a semi-rugged laptop might have a thicker case, a gel-mounted hard disk drive and a spill-resistant keyboard.

Fully-rugged devices

Fully-rugged devices are designed from the inside-out to work in extreme temperatures, to be impervious to being dropped, to resist shocks and vibrations and to be dustproof and waterproof. A fully-rugged laptop may have a solid state hard drive, which has no moving parts, runs cool and doesn't need for a fan. (Another moving part that adds weight to the device.)

Ultra-rugged devices

Ultra-rugged devices, which are usually designed to meet precise specifications for military use, are made to handle the harshest environmental conditions. An ultra-rugged laptop can be left out in a sandstorm, frozen in a blizzard or sent on a vibrating rocket into space without any detrimental effects.

Conditions of Rugged system

Environmental conditions and tests, Low Pressure (Altitude) ,High Temperature , Low Temperature ,Temperature Shock, Contamination by Fluids , Solar Radiation (Sunshine) ,Rain , Humidity, Fungus ,Salt Fog ,Sand and Dust , Explosive Atmosphere , Immersion ,Acceleration, Vibration, Acoustic Noise , Shock , Pyroshock , Acidic Atmosphere.

III. CATGORY OF RUGGED SYSTEMS

Many of the innards of rugged systems are the same as those of other notebooks. Processors, core logic, memory, even motherboards and hard drives are no different. The exceptions begin where these components touch other subsystems. A category of ruggedness, then, can be thought of not so much as the inclusion of a technology, such as shock mounting, but as an effect, the result of technologies individually or in combination. Thus, we will classify "drop resistance" rather than "has shock mounting." How, various companies achieve these results is for them to market to their respective audiences, but in classifying systems we will look at how systems stack up against various accepted rugged standards, both in an absolute sense (meets vs. does not meet) and in a relative sense (meets 85% of full specification). Also, points are given for third-party verification.

Rugged +

In this rating, a system that exceeds 420 points, that meets all and exceeds some parts of the definition of rugged according to Military Standard 810F and Ingress Protection, and whose results have been independently verified by a certified testing laboratory, meets Rugged +.

Rugged

In this rating, a system that garners 330-419 points, that meets the full definition of rugged according to Military Standard 810F and Ingress Protection, and whose results have been independently verified by a certified testing laboratory, meets Rugged.

Rugged –1

In this rating, a system that garners 150-329 points, that meets some parts of or partially meets the definition of rugged according the Military Standards 810F and Ingress Protection, and whose results have been independently verified by a certified testing laboratory, meets Rugged 1.

Rugged –2

In this rating, a system that garners 70-149 points, that meets some parts of or partially meets the definition of rugged according to the Military Standards 810F and Ingress Protection, and whose results may or may not have been independently verified by a certified testing laboratory, meets Rugged –2.

Non-rugged

In this rating, a system that garners 0-69 points, that may arbitrarily meet some parts of or partially meet the definition of rugged according to the Military Standards 810F and Ingress Protection, but is not designed to do so and makes no claims with respect to ruggedness, is considered Non-rugged.

IV. RUGGED CASE

When you transport equipment, your sensitive gear is subjected to drops, falls and harmful repetitive vibration. That's where the state-of-the-art, shock mounted Rack-Pack comes in. Rugged Racks come standard with military-proven shock isolation mounts to mitigate and eliminate these threats. Custom-fabricated to cradle your unique equipment

All frames feature an independent shock-mounting system without rigid connections. The elastomeric mounts act as buffers to provide sway space and eliminate shock. What does that mean for you? It means when an overly aggressive bag handler launches your Rack-Pack across the tarmac, the rugged military-grade outer shell flexes to help dissipate shock upon impact. Inside, the isolation mounts flex prevent damaging shock from traveling into the protective frame—keeping your sensitive gear safe, sound and unscathed.

The rugged case is a Commercial off-the-shelf (COTS) is used in a harsh military, or otherwise high vibration, or temperature extreme environment. These modules can be combined to provide a variety of functionalities that are particularly useful in military and commercial environments.

This casing is mostly used in the military use like gun casing, small casing, medium casing, laptop casing, medicine casing, rolling casing and DSLR casing.

Applications of rugged Casing

Military Casing

Military cases - rugged transit containers and shipping cases - are used every day by the Army, Navy, Air Force, Coast Guard, and Marines to protect and transport sensitive electronic equipment and weapons systems. Our wide selection of stock rack mounts is available for immediate delivery; many models are airtight and waterproof. For delicate equipment requiring custom foam interiors or fully isolated rack-mounting systems, we can design a case to meet your specific requirements.

The military case of choice since 1958 every branch of Indian military to protect their sensitive gear. Everything from delicate radiation test stations, guided missiles, Home drive train parts, aircraft engine parts, simulation training devices, WMD contamination kits, mobile computer systems, troop weapons cases and so on.



Fig: Military casing

Gun Casing:

This is exclusively designed for the military and law enforcement officers. There are durable, light and incredibly compact. This protects from extreme environments. This casing can be varies from shot gun to sniper gun.



Fig: Gun casing

V. MATERIAL USED IN RUGGED CASE

There are different materials that are used in outer case of rugged box, the material should be as strong as rock light weight and fire resistance etc. the present materials that are used in rugged case box are Cast Iron, copper alloys, aluminum alloys, and combination of high carbon steels.

We are tacking the aluminum 6061 in designing the rugged outer case

Alloy 6061 is one of the most widely used alloys in the 6000 series. This standard structural alloy, one of the most versatile of the heat-treatable alloys, is popular for medium to high strength requirements and has good toughness characteristics. 6061 produces for use in standard and custom, solid and hollow shapes, rod and bar products, and seamless and structural pipe and tube.

Alloy 6061 has excellent corrosion resistance to atmospheric conditions and good corrosion resistance to seawater. This alloy also offers good finishing characteristics and responds well to anodizing; however, where cosmetic appearance is critical, consider the use of alloy 6063. The most common anodizing methods include clear, clear and color dye, and hard coat.

Alloy 6061 is easily welded and joined by various commercial methods. (Caution: direct contact by dissimilar metals can cause galvanic corrosion.) Since 6061 is a heat-treatable alloy, strength in its -T6 condition can be reduced in the weld region.

Selection of an appropriate filler alloy will depend on the desired weld characteristics. Consult the Material Safety Data Sheet (MSDS) for proper safety and handling precautions when using alloy 6061.



www.ijarse.com

Aluminum alloys are divided into casting alloys and wrought alloys, and are best suited for different applications. Wrought aluminum alloys, such as the 6061 alloy, are worked by extruding, rolling or forging them into specified shapes. Some alloys can be heat-treated or cold-worked by different methods to increase their strength and hardness, corrosion resistance, ease of fabrication and other advantages.

Wrought and cast alloys are first graded by a 4-digit number which identifies their major alloying element. For example, 2XXX includes copper, 4XXX includes silicon, and 6XXX includes magnesium and silicon.

The alpha-numeric suffixes attached to alloys, such as 6061-T6, represent the temper, or degree of hardness. They also represent the method by which the hardness was obtained. In the case of 6061-T6 aluminum alloy, the "T6" indicates that it was solution heat-treated and artificially aged. The suffixes may include additional numbers. For instance, -T6511 would indicate that the alloy was solution heat-treated, stress-relieved by stretching, and artificially aged to reduce the possibility of distortion in machined parts.

Aluminum 6061 Properties

6061 aluminum properties include its structural strength and toughness. It is also offers good finishing characteristics and responds well to anodizing, including clear, clear and color dye, and hard coat. 6061 aluminum alloy is also easily welded and joined. However, in its -T6 condition the welds may lose some strength, which can be restored by re-heat-treating and artificially aging.

Chemical Composition of Aluminum 6061

Element	% Present
Magnesium (Mg)	0.80 - 1.20
Silicon (Si)	0.40 - 0.80
Iron (Fe)	0.0 - 0.70
Copper (Cu)	0.04 - 0.35
Chromium (Cr)	0.0-0.25
Zinc (Zn)	0.0-0.15
Titanium (Ti)	0.0-0.15
Manganese (Mn)	0.0-0.15
Others (Total)	0.0-0.05
Aluminium (Al)	Balance

Generic Physical Properties of Aluminum 6061

Property	Value
Density	2.70 g/cm
Melting Point	650 °C
Thermal Expansion	23.4 x10-6 /K
Modulus of Elasticity	70 GPa
Thermal Conductivity	166 W/m.K
Electrical Resistivity	0.040 x10-6 Ω .m

Mechanical Properties of Aluminum 6061

Property	Value
Proof Stress	240 Min MPa
Tensile Strength	260 Min MPa
Hardness Brinell	95 HB

Applications of Aluminum 6061 alloys

Aluminum in its purest form is too soft and reactive to be of structural use. However, its alloys, such as 6061-T6 alloy, make it structurally stronger and more useful in the manufacturing of durable products.

6061-T6 aluminum is commonly used in aircraft construction. Although primarily used in private rather than commercial aircraft, its strength-to-weight ratio is very high, making it ideal for large parts that need to be very light, such as the plane’s fuselage and wings. This light weight also made 6061-T6 aluminum the best choice for the famous gold-anodized plaques that were mounted on board the 1972 Pioneer 10 and 1973 Pioneer 11 spacecraft.

6061-T6 aluminum properties make it a material of choice for builders of boats and watercraft because it’s strong and lightweight. It is ideal for sailboat masts and for hulls of larger yachts that cannot be made from fiberglass. Small, flat-bottom canoes are almost entirely fabricated from 6061-T6, although the bare aluminum is often coated with protective epoxy to improve its resistance to corrosion.

Other common applications of 6061-T6 aluminum include bicycle frames, applications where heat transfer is required, such as heat exchangers, air coolers and heat-sinks, and applications where 6061-T6’s non-corrosive characteristics are important, such as water, air and hydraulic piping and tubing.

Alloy 6061 is typically used for heavy duty structures in:

www.ijarse.com

- Rail coaches
- Truck frames
- Ship building
- Bridges and Military bridges
- Military rugged cases
- Aerospace applications including helicopter rotor skins
- Tube
- Pylons and Towers

BRIEF DESCRIPTION OF DRAWINGS

We need to design the this system and need to do thermal analysis



3-D MODELS OF RUGGED SYSTEM:

Rugged Outer case:

Fan Tray:

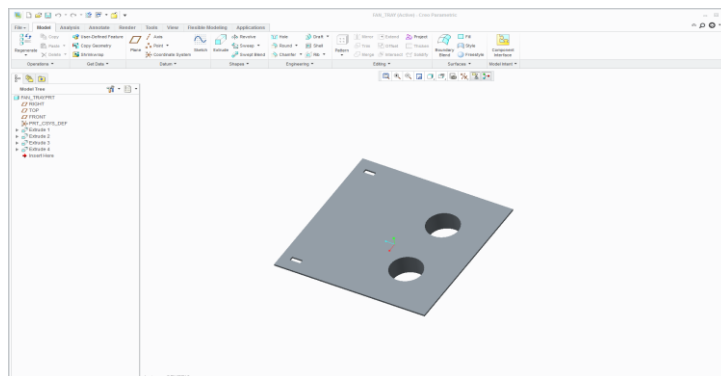

Electronic system Rack:

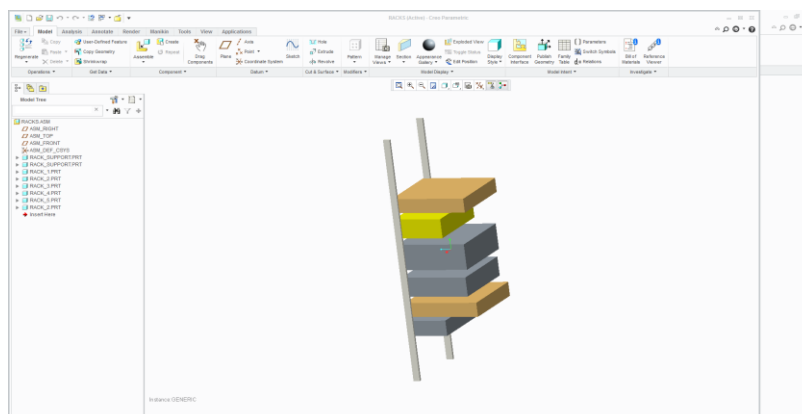

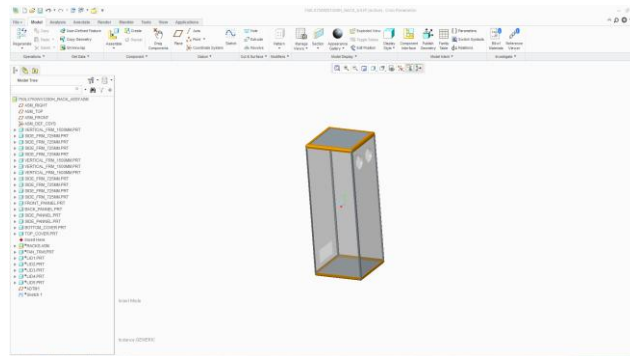

Rugged case assembled with electronic system:

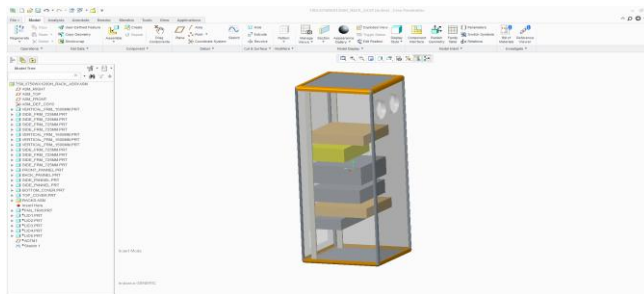

Rugged case, electronic system and Fan tray Assembly:

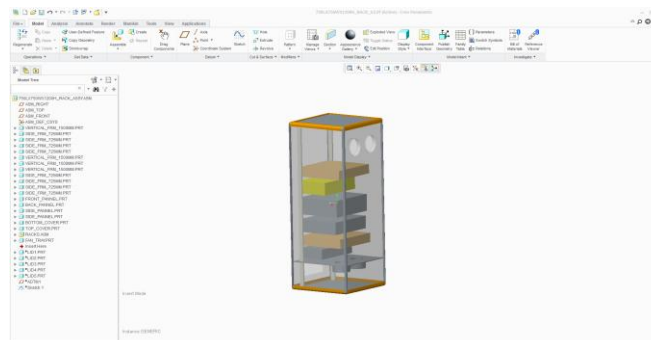

Fans assembled at bottom left corner of electronic systems:

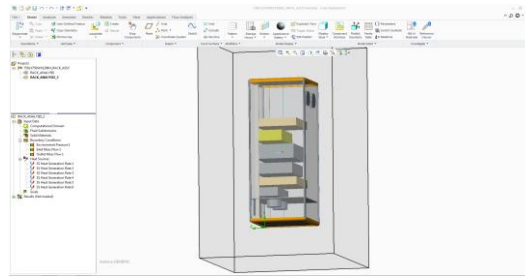

Fans assembled at bottom right corner of system

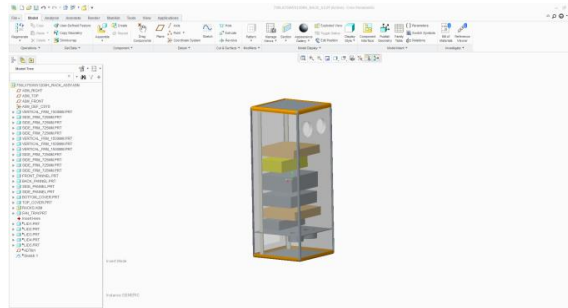

Existing Model of Rugged System used in vehicleS

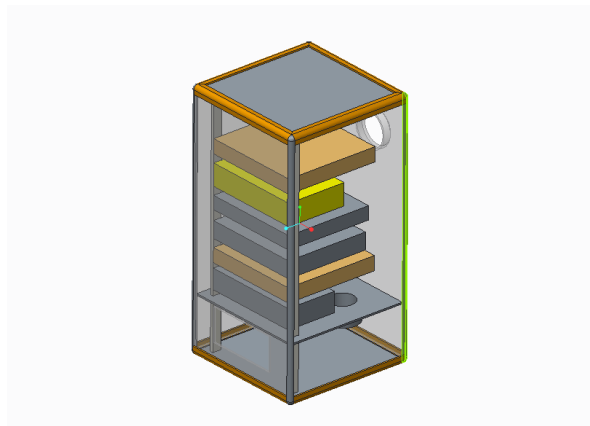

EXPLODED VIEW OF MODIFIED MODEL

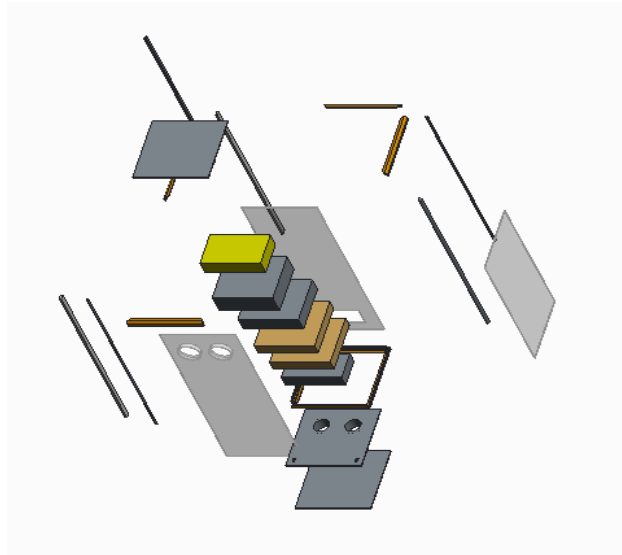

FRONT VIEW

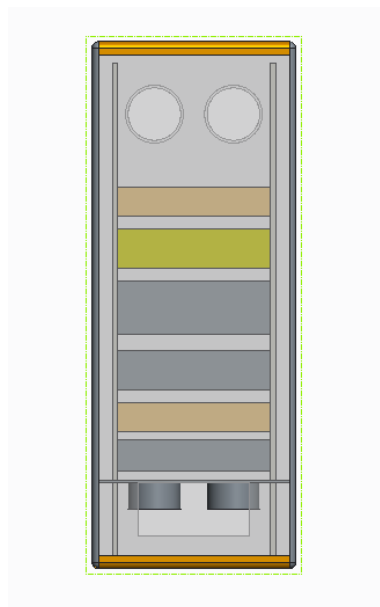

Problem-Solving with CFD

There are many decisions to be made before setting up the problem in the CFD code. Some of the decisions to be made can include: whether the problem should be 2D or 3D, which type of boundary conditions to use, whether or not to calculate pressure/temperature variations based on the air flow density, which turbulence model to use, etc. The assumptions made should be reduced to a level as simple as possible, yet still retaining the most important features of the problem to be solved in order to reach an accurate solution.

After the above decisions are made, the geometry and mesh can be created. The grid should be made as fine as required to make the simulation 'grid independent'. To determine the fineness required, a grid dependence study is normally carried out by making a series of refinements on an initially course grid, and carrying out simulations on each to determine when the key results of interest do not change, at which point the grid is considered independent. In this project, a grid with approximately 50,000 cells was chosen after carrying out such a study (described in the next section). To reach a converged solution, relaxation factors and acceleration devices can be chosen. In this project, relaxation factors for all the parameters to be solved and the GAMG smooth-solver for pressure were used to assist in convergence and speed optimisation.

Floefd for creo Solvers

Three solvers were used for simulating the ten cases representing each of the Reynolds numbers. The simple Foam solver solves only for flow fields, while Simple Foam solves for flow and temperature under steady-state conditions, and rhoTurbFoam also solves flow and temperature, but for transient cases.

Input Details:

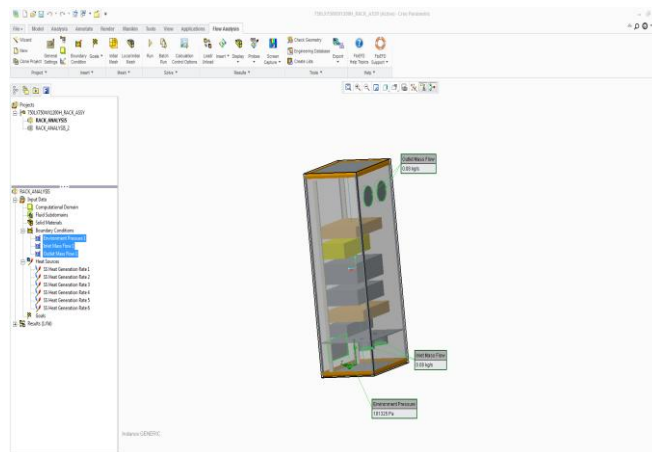

Analysis under 0.29CFM

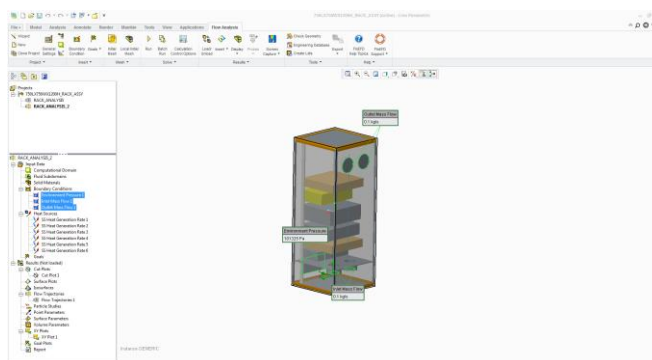

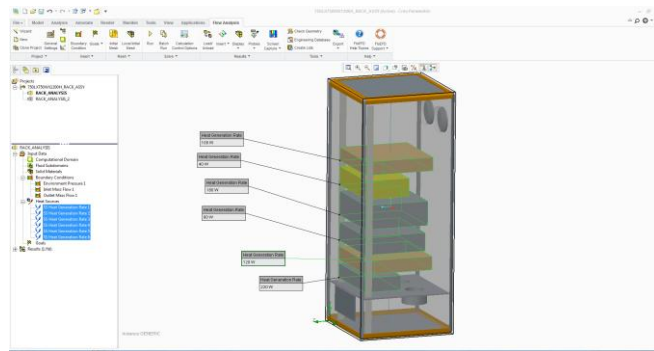

Analysis under 0.25 CFM

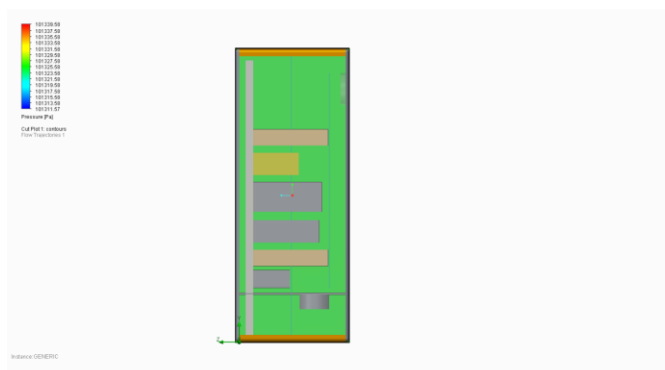
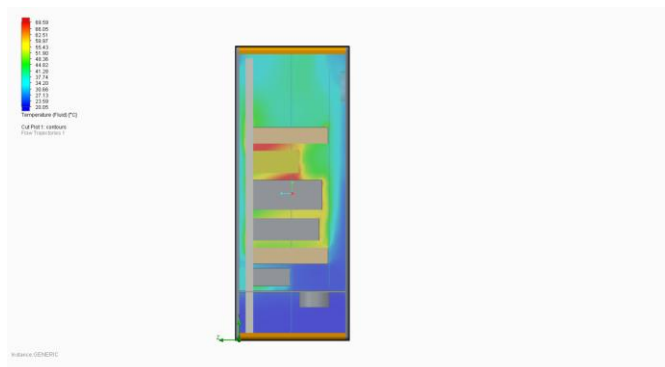
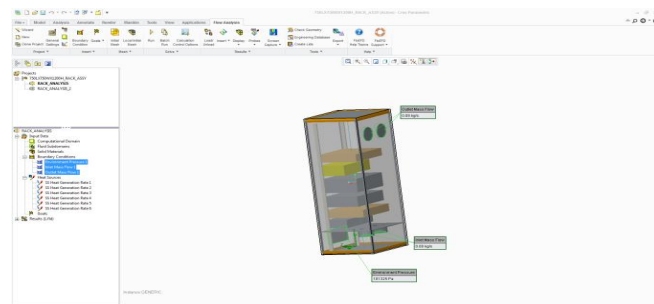

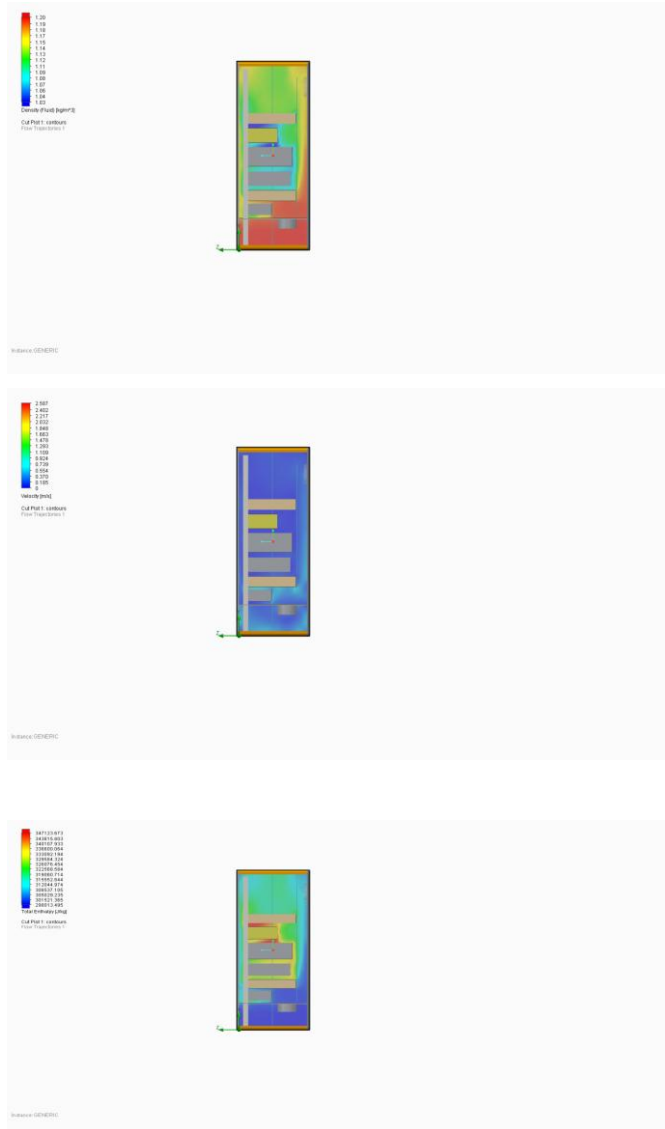

TEMPERATURE GRAPH OF SIDE FAN_0.25 CFM

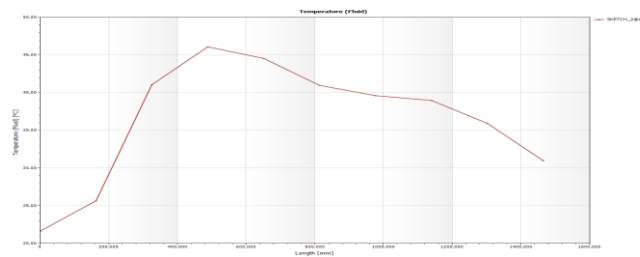

TABULAR COLUMN OF TEMPERATURE_0.25 CFM

Temperature (Fluid) (°C)	Length (mm)
21.63162	0
25.66081927	162.777778
41.06203553	325.555556

488.3333333	46.07903379
651.1111111	44.54211416
813.8888889	40.96689189
976.6666667	39.6050116
1139.444444	38.96861526
1302.222222	35.9315987
1465	30.98534128

DENSITY GRAPH OF SIDE FAN_0.25 CFM

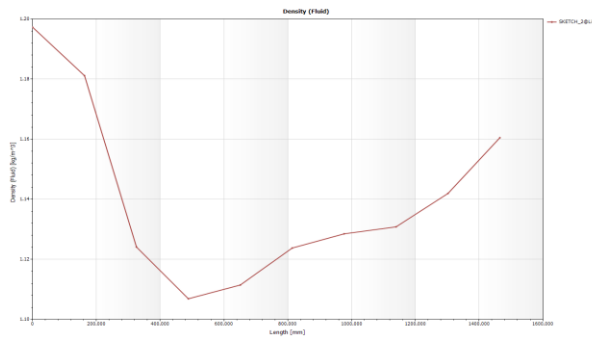

TABULAR COLUMN OF DENSITY_0.25 CFM

Density (Fluid) (kg/m ³)	
Length (mm)	SKETCH_2@Line1
0	1.197249222
162.7777778	1.181124469
325.5555556	1.124108201
488.3333333	1.106880938
651.1111111	1.111443006
813.8888889	1.123757846
976.6666667	1.128483778
1139.444444	1.130804054
1302.222222	1.141926652
1465	1.160465541

PRESSURE GRAPH OF SIDE FAN_0.25 CFM

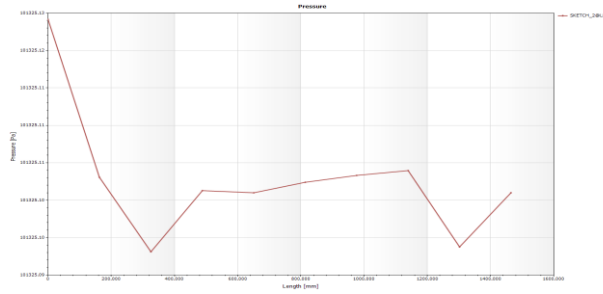

TABULAR COLUMN OF PRESSURE_0.25 CFM

Pressure (Pa)	
Length (mm)	SKETCH_2@Line1
0	101325.1242
162.7777778	101325.1031
325.5555556	101325.0931
488.3333333	101325.1013
651.1111111	101325.101
813.8888889	101325.1024
976.6666667	101325.1033
1139.444444	101325.104
1302.222222	101325.0938
1465	101325.101

ENTHALPY GRAPH OF SIDE FAN_0.25 CFM

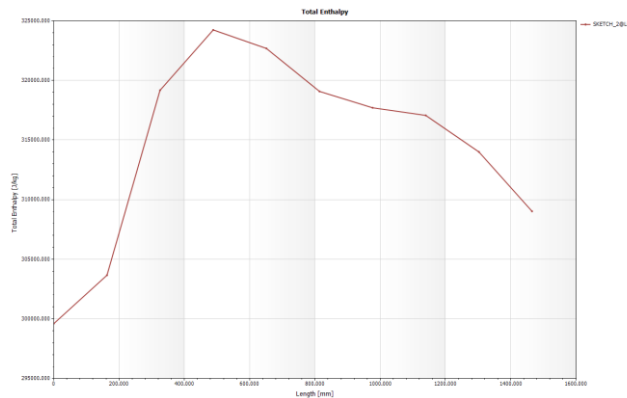

TABULAR COLUMN OF ENTHALPY_0.25 CFM

Total Enthalpy (J/kg)	
Length (mm)	SKETCH_2@Line1

0	299605.7374
162.7777778	303662.3676
325.5555556	319178.29
488.3333333	324236.1645
651.1111111	322684.8211
813.8888889	319080.6391
976.6666667	317707.8342
1139.444444	317066.6126
1302.222222	314006.7071
1465	309024.1997

VELOCITY GRAPH OF SIDE FAN_0.25 CFM

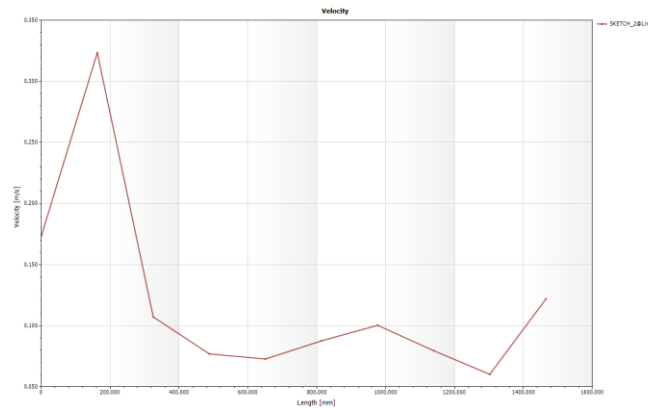

TABULAR COLUMN OF VELOCITY_0.25 CFM

Velocity (m/s)	Length (mm)
0.173274735	0
0.323315362	162.7777778
0.107160634	325.5555556
0.076986419	488.3333333
0.072820959	651.1111111
0.087715038	813.8888889
0.100373907	976.6666667
0.079615967	1139.444444
0.060280017	1302.222222
0.121909409	1465

In our project we have designed a Rugged System Used in Defense Applications and modeled in 3D modeling software CREO-2.0 and we analyze the Rugged System with different positions in the fan of a electronic system.

In this Project we describe the Best Position of Fans and CFM. By using FLOEFD Software the cfd analysis is performed.

ANALYSIS RESULTS system with fan at bottom left corner at Different CFM

0.25 CFM – TEMPERATURE – 35.1050773 C

0.29 CFM – TEMPERATURE – 32.1479 C

ANALYSIS RESULTS system with fan at bottom left at Different CFM

0.25 CFM – TEMPERATURE – 30.985341 C

0.29 CFM – TEMPERATURE – 29.1426665 C

So we are to Conclude & analyze the Best Position of Fan At CFM 0.25 CFM – TEMPERATURE – 35.1050773C FOR SYSTEM HAVING FAN AT BOTTOM LEFT CORNOR is Best position to place the fan because here the temperature is dissipating at more rate that others. so the electronic system in cabinet is safe from highest temperatures.

REFERENCES

1. S. Dasmahapatra, B. K. Sarkar, R. Saha, A. Chatterjee, S. Mookherjee, D. Sanyal, Design of an Adaptive-Fuzzy-Bias-SMC and Validation for a Rugged Electrohydraulic System, IEEE/ASME transaction on mechatronics, 20, 6, Page Nos - 2708-2715, 2015
2. GA-optimized feedforward-PID tracking control for a rugged electrohydraulic system design BK Sarkar, P Mandal, R Saha, S Mookherjee, D Sanyal.
3. P. Mandal, B. K. Sarkar, R. Saha, S. Mookherjee, S. K. Acharyya and D. Sanyal, 2015, GA-optimized fuzzy-feedforward-bias control of motion by a rugged electrohydraulic system, IEEE/ASME Trans. Mechatronics, DOI 10.1109/TMECH.2014.2352156, 20 (4) 1734-42.
4. Dave Turner, Case study: Designing for rugged thermal management to meet military needs .
5. RUGGED SYSTEM –WIKIPEDIA.